



## PTE7100 SERIES

- The pressure sensor detects the system pressure and converts it into an analog output signal.
- These operating instructions contain important information on handling the instrument.
- All safety instructions and work instructions should be observed to prevent injury or harm.
- Observe the relevant local accident prevention regulations and general safety regulations for the instrument's range of use.
- The operating instructions are part of the product and must be kept in the immediate vicinity of the instrument and readily accessible to skilled personnel at any time. Pass the operating instructions on to the next operator or owner of the instrument.
- The general terms and conditions contained in the sales documentation shall apply.
- Subject to technical modifications.



### SAFETY INSTRUCTIONS

- Skilled personnel must have carefully read and understood the operating instructions prior to beginning any work.
- Please read this document prior to set-up of the unit. Ensure that the product is suitable for your application without any restrictions.
- If the operating instructions or the technical data are not adhered to, personal injury and/or damage to property can occur.
- Improper or non-intended use may lead to malfunctions of the unit or to unwanted effects in your application. That is why installation, electrical connection, set-up, operation and maintenance of the unit must only be carried out by qualified personnel authorized by the machine operator.
- In order to guarantee the correct condition of the device for the operating time, it is necessary to use the device only for media to which the wetted materials are sufficiently resistant.
- The responsibility whether the measurement devices are suitable for the respective application lies with the operator. The manufacturer assumes no liability for consequences of misuse by the operator. Improper installation and use of the devices results in a loss of the warranty claims.

### Explanation of Symbols



#### WARNING!

...indicates a potentially dangerous situation that can result in serious injury or death, if not avoided.



#### CAUTION!

...indicates a potentially dangerous situation that can result in light injury or damage to property or the environment, if not avoided.



#### INFORMATION

...points out useful tips, recommendations and information for efficient and trouble-free operation.



### FUNCTIONS AND FEATURES

#### Pressures

- The pressure transmitter is used for measuring pressure. The measured pressure is output as an electrical signal. Proper pressure range should be selected based on application requirement.

From 0 to ...	barG	50	100	200	250	350	400	600
Proof Pressure	barG	200	200	400	500	800	800	1200
Burst Pressure	barG	2000	2000	4000	4000	4000	4000	4000



Avoid overload pressure exceeding the specified maximum permissible pressure by taking appropriate measures. The indicated bursting pressure must not be exceeded. Even if the bursting pressure is exceeded only for short time, the unit may be destroyed. ATTENTION: Risk of injury!

#### Pressure Port Connections

7/16-20 UNF-2A (MALE)

G1/4A DIN 3852-E

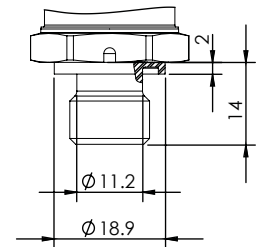
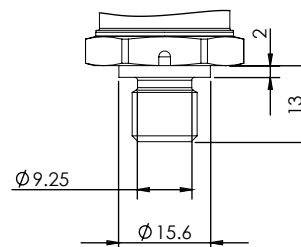

1/4-19 PT (R1/4)

1/4-18 NPTF

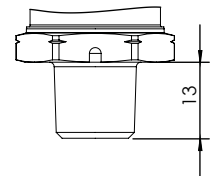
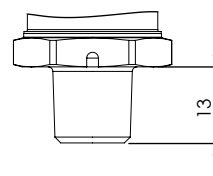

## Electrical Connections

PACKARD METRI-PACK 150  
IP67

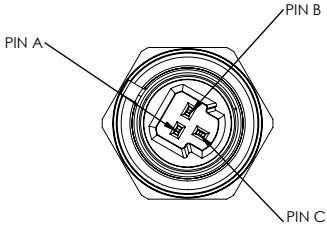
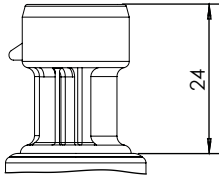

Output Type	PIN A	PIN B	PIN C
<b>Voltage</b>	V-	V+	Vout
<b>Current</b>	lout	V+	...

M12x1 4-POLE  
IP67

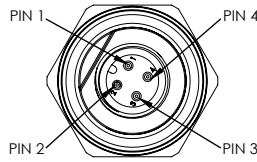
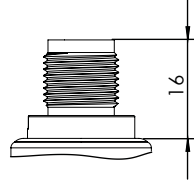

Output Type	PIN 1	PIN 2	PIN 3	PIN 4
<b>Voltage</b>	V+	...	V-	Vout
<b>Current</b>	V+	...	lout	...

A: DIN 175301-803 FORM A(18mm)  
IP65

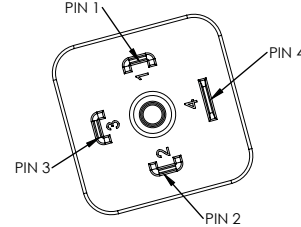
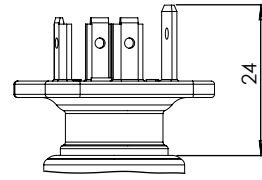

Output Type	PIN 1	PIN 2	PIN 3	PIN 4
<b>Voltage</b>	V+	V-	Vout	...
<b>Current</b>	V+	lout	...	...

DEUTSCH DT04-3P  
IP67

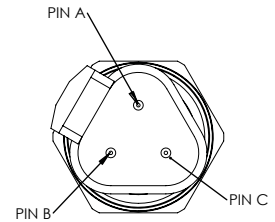
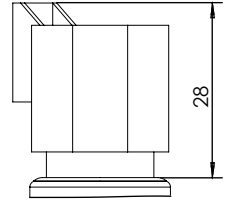

Output Type	PIN A	PIN B	PIN C
<b>Voltage</b>	V+	V-	Vout
<b>Current</b>	V+	lout	...

FLY LEAD WITH HARNESS  
IP67

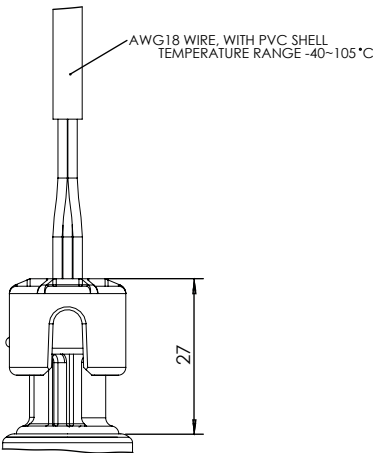

Output Type	RED	BLACK	WHITE
<b>Voltage</b>	V+	V-	Vout
<b>Current</b>	V+	lout	...



## INSTALLATION



Before installing and removing the unit: Make sure that no pressure is applied to the system.

Only use the pressure transmitter if it is in perfect condition with respect to safety. Prior to commissioning, the pressure transmitter must be subjected to a visual inspection. Leaking fluid is indicative of damage.

The mounting point must meet the following conditions:

- Sealing faces are clean and undamaged.
- Sufficient space for a safe electrical installation.
- Permissible ambient and medium temperatures remain within the performance limits. Consider possible restrictions on the ambient temperature range caused by mating connector used.

Tighten firmly. Recommended tightening torque:

Final value of the measuring range in bar	Tightening torque in Nm
10...400	25...35
600	30...50
Depends on lubrication, seal on pressure rating!	

### Sealing Variants

#### Parallel threads

Seal the sealing face  with gasket and O-ring sealing.

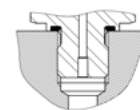

per SAE J1926-3

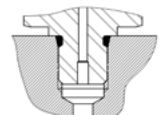

per DIN 3852-E

#### Tapered threads

Wrap threads with sealing material (e.g. PTFE tape).

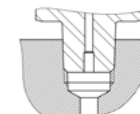

NPT, R and PT



Electrical

<b>Pressure Ranges</b>	0-50 to 0-600 bar (0-725 to 0-8700 psi)
<b>Pressure Reference</b>	Gauge
<b>Supply Voltage/Output</b>	8-32VDC for 4-20mA output 5±0.25VDC for 0.5-4.5VDC output 8-32VDC for 0-5VDC output 12-32VDC for 0-10VDC output 8-32VDC for 1-5VDC output 8-32VDC for 0.5-4.5VDC output
<b>Output Load</b>	≥ 4.7 kΩ for voltage output ≤ (Vsup-8)/20mA for current supply
<b>Output Response Time</b>	<2 ms
<b>Overvoltage Protection</b>	36 VDC
<b>Reverse Voltage Protection</b>	Yes
<b>Short Circuit Protection</b>	Yes
<b>Insulation Resistance</b>	> 100 MΩ at 500V
<b>EMC</b>	IEC 61326-1 and EN 61326-2-3
<b>Dielectric Strength</b>	500 VAC
<b>Enhanced Radiated Immunity</b>	100V/m (80~200MHz) 200V/m (200~2700MHz)
<b>Enhanced ESD</b>	±8KV Contact; ±15KV Air

Physical

<b>Random Vibration</b>	IEC 60068-2-6, 30g (10...2000Hz)
<b>Mechanical Shock</b>	EN 60068-2-27, 500 g
<b>Drop (any Axis)</b>	1m
<b>Ingress Protection</b>	IP65 - IP67 (see Connector Options)
<b>Media Compatibility</b>	Fluids and Gases compatible with 17-4PH stainless steel

Performance

<b>Accuracy (Best Fit Straight Line)<sup>(1)</sup></b>	±0.25%FS @25°C
<b>Accuracy (Total Error Band)<sup>(2)</sup></b>	+/-1.5%FS @-20° to 85°C
<b>Operating Endurance</b>	>10M cycles
<b>Operating Ambient Temperature</b>	-40° to +100°C
<b>Operating Media Temperature</b>	-40° to +125°C
<b>Storage Temperature</b>	-40° to +125°C <sup>(3)</sup>

<sup>(1)</sup> Best fit straight line accuracy includes errors from non-linearity, non-repeatability, and hysteresis

<sup>(2)</sup> Total error band accuracy includes errors from non-linearity, non-repeatability, hysteresis, zero offset, full span offset, and thermal effects

<sup>(3)</sup> PVC flying leads are rated for storage of -40° to +105°C

Sensata Technologies, Inc. ("Sensata") data sheets are solely intended to assist designers ("Buyers") who are developing systems that incorporate Sensata products (also referred to herein as "components"). Buyer understands and agrees that Buyer remains responsible for using its independent analysis, evaluation and judgment in designing Buyer's systems and products. Sensata data sheets have been created using standard laboratory conditions and engineering practices. Sensata has not conducted any testing other than that specifically described in the published documentation for a particular data sheet. Sensata may make corrections, enhancements, improvements and other changes to its data sheets or components without notice.

Buyers are authorized to use Sensata data sheets with the Sensata component(s) identified in each particular data sheet. HOWEVER, NO OTHER LICENSE, EXPRESS OR IMPLIED, BY ESTOPPEL OR OTHERWISE TO ANY OTHER SENSATA INTELLECTUAL PROPERTY RIGHT, AND NO LICENSE TO ANY THIRD PARTY TECHNOLOGY OR INTELLECTUAL PROPERTY RIGHT, IS GRANTED HEREIN. SENSATA DATA SHEETS ARE PROVIDED "AS IS". SENSATA MAKES NO WARRANTIES OR REPRESENTATIONS WITH REGARD TO THE DATA SHEETS OR USE OF THE DATA SHEETS, EXPRESS, IMPLIED OR STATUTORY, INCLUDING ACCURACY OR COMPLETENESS. SENSATA DISCLAIMS ANY WARRANTY OF TITLE AND ANY IMPLIED WARRANTIES OF MERCHANTABILITY, FITNESS FOR A PARTICULAR PURPOSE, QUIET ENJOYMENT, QUIET POSSESSION, AND NON-INFRINGEMENT OF ANY THIRD PARTY INTELLECTUAL PROPERTY RIGHTS WITH REGARD TO SENSATA DATA SHEETS OR USE THEREOF.

All products are sold subject to Sensata's terms and conditions of sale supplied at [www.sensata.com](http://www.sensata.com) SENSATA ASSUMES NO LIABILITY FOR APPLICATIONS ASSISTANCE OR THE DESIGN OF BUYERS' PRODUCTS. BUYER ACKNOWLEDGES AND AGREES THAT IT IS SOLELY RESPONSIBLE FOR COMPLIANCE WITH ALL LEGAL, REGULATORY AND SAFETY-RELATED REQUIREMENTS CONCERNING ITS PRODUCTS, AND ANY USE OF SENSATA COMPONENTS IN ITS APPLICATIONS, NOTWITHSTANDING ANY APPLICATIONS-RELATED INFORMATION OR SUPPORT THAT MAY BE PROVIDED BY SENSATA.

Mailing Address: Sensata Technologies, Inc., 529 Pleasant Street, Attleboro, MA 02703, USA.

CONTACT US

Americas

+1 (800) 350 2727  
sensors@sensata.com  
switches@sensata.com

Europe, Middle East & Africa

+359 (2) 809 1826  
pressure-info.eu@sensata.com

Asia Pacific

sales.isasia@list.sensata.com  
China +86 (21) 2306 1500  
Japan +81 (45) 277 7117  
Korea +82 (31) 601 2004  
India +91 (80) 67920890  
Rest of Asia +886 (2) 27602006  
ext 2808